

WITH GERMAN TOUCH

HOLO
SANITARY WARE

HOLO SANITARYWARE PVT. LTD.

Survey No. 723-724, Old Ghuntu Road,
Nr. Evernew Paper Mill, Morbi - 363642, Gujarat, India.

For Export Inquiry

info@holosanitaryware.com
+91 99093 79000

For Domestic Inquiry

holosanitaryware@gmail.com
+91 99093 78000



scan to e-catalogue download

www.holosanitaryware.com   

Trend Design - 85 1111 519

www.holosanitaryware.com

HOLO
SANITARY WARE



COLLECTION - 2024-25

**With
German
Touch**

EXCLUSIVE
SANITARYWARE COLLECTION

GERMAN
TECHNOLOGY
www.holosanitaryware.com



HOLO
SANITARY WARE

M A D E I N I N D I A

A brand story:

Holo Sanitary Wares Pvt. Ltd. stands as one of Morbi's largest manufacturers of high-quality sanitary wares. With a robust manufacturing capacity of 2200 pieces per day, scalable up to 3000 pieces, we are dedicated to fulfilling the ever-growing demands of our valued customers.

Our cutting-edge factory spans over 500,000 square feet, including 300,000 square feet of constructed area. We also provide 200 1 BHK accommodations for our skilled co-workers, ensuring a modern, positive work environment that fosters well-being and productivity.

Our Vision:

At Holo Sanitary Wares Pvt. Ltd., our vision is to lead the industry with high-quality, durable sanitary water products while fostering strong relationships with our business associates. Our commitment to excellence, innovation, and sustainable practices ensures that we not only meet but exceed the expectations of our valued customers.

With a solid foundation built on expertise and a forward-thinking approach, we are poised to become the foremost manufacturer of sanitary water products. Our dedication to quality and sustainability drives every aspect of our operations, ensuring a brighter, cleaner future for all.

OUR TEAM : EXPERTISE AND DEDICATION

At the heart of our company are two distinguished leaders, Mr. Amit Sachde and Mr. Girish Vadaviya, whose combined expertise drives our success.

Mr. Amit Sachde has been a pivotal figure in the ceramic industry since 2001. With a career spanning over two decades, his extensive experience includes a significant tenure at Somany Ceramics, starting in 2010. His profound knowledge and innovative approach have been instrumental in propelling our company to new heights.

Mr. Girish Vadaviya brings a wealth of financial consultancy experience and an in-depth understanding of the insurance industry, dating back to 2005. His expertise extends to labor law consultancy, adding a vital dimension to our strategic operations. His multifaceted skills ensure our company's robust financial health and compliance.

COMMITMENT TO SUSTAINABILITY

Our dedication to sustainability is at the core of our operations. We are committed to protecting the environment through a series of innovative initiatives:

Water Conservation : Implementing cutting-edge techniques to minimize water consumption in our production processes, ensuring efficient use of this precious resource.

Renewable Energy : Harnessing the power of solar energy and utilizing green fuels for 50% of our energy needs. These measures significantly reduce our carbon footprint and contribute to a greener planet.

Zero Waste Emissions : Striving to achieve zero waste emissions through comprehensive recycling and reuse strategies. By recycling wastewater and materials, we are making strides towards a more sustainable future.



MEET OUR TEAM

Certificate

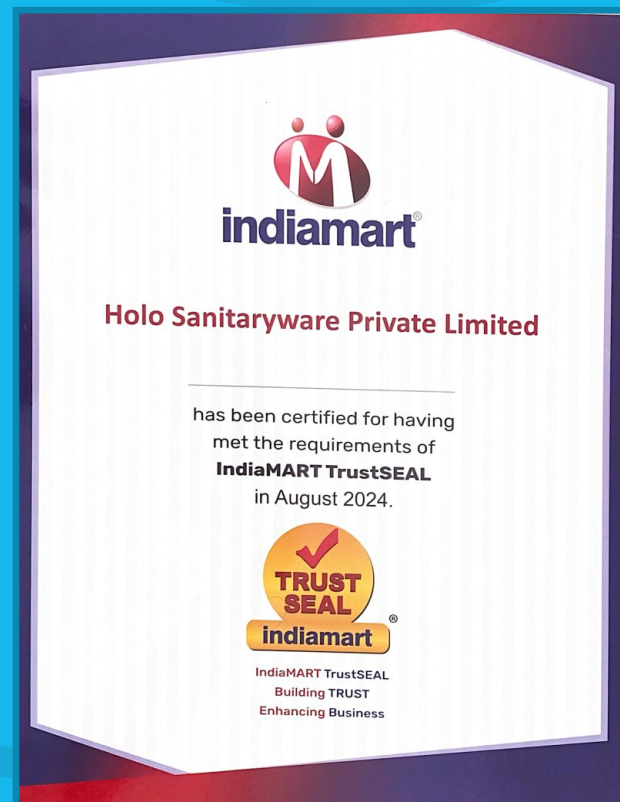

Manoj Godhani - HR Department

Manoj Godhani has been an integral part of the ceramic industry since 2003. With over 20 years of experience, his expertise and leadership have been pivotal in driving success and efficiency. Under his guidance, a dedicated team of over 2000 workers consistently meets the highest standards of production in all aspects of our operations. His commitment to fostering a positive work environment ensures our team is motivated and productive, contributing significantly to our overall success.

Milan Thoriya - Account Department

Milan Thoriya possesses a deep understanding of account management and operations, with over 10 years of experience in the field. Notably, he has served as an accomplished accountant at Patidar Enterprise for over 5 years. Milan's expertise in financial planning and analysis has been instrumental in contributing to our company's success. His attention to detail and strategic approach ensure our financial health and compliance with industry standards.

Mehul Ratanpara - Account Department

Mehul Ratanpara has been associated with the financial industry since 2011. As the Chief Accountant at Vinayak Corporation, he has played a crucial role in managing and overseeing all financial aspects of the company. His expertise contributes to our commitment to maintaining financial stability and transparency. Mehul's strategic financial management skills help us optimize resources and ensure sustainable growth.

Deep Savsani - Marketing Department

Deep Savsani has been diving into the sanitaryware industry since 2020. With a fresh perspective and enthusiasm, he has made a significant impact. His previous experience as a Marketing Executive at Sezanza Wall Tiles, where he earned worthwhile expertise, helps us effectively promote and position our ceramic products. Deep's innovative marketing strategies and keen market insights ensure our products reach the right audience and achieve maximum visibility.

Hemal Shah - Marketing Department

Hemal Shah has been connected with various industries since 2000, including sanitaryware, paper mills, tile, and plastic industries. His diverse background and extensive marketing expertise make him a valuable asset to our team. Hemal has a vast network of dealer and channel partners, which is instrumental in expanding our market reach and establishing strong relationships within the industry.

Chirag Aervadiya - Production Department

Chirag Aervadiya established a strong presence in the sanitaryware industry in 2016. With 2 years of valuable experience in Micron Industries, he joined Bell Sanitaryware as Production Head. Throughout his journey, Chirag has honed his skills and earned a deep understanding of the field. His industry knowledge ensures our team continues to deliver exceptional sanitaryware products to our valued customers, maintaining our reputation for quality.

Kamran Chaniya - Production Department

Kamran Chaniya brings a wealth of expertise and a rich background in the sanitaryware industry since 2006. His leadership ensures seamless operations and superior product quality. Kamran has also served as a production manager at Simpulo Sanitaryware for 8 years and held the position of production in charge at Eros for Sanitaryware for 9 years. His extensive experience and hands-on approach drive operational excellence and continuous improvement.

Nitesh Bhatasna - Production Department

Nitesh Bhatasna has a longstanding association with the Brass and Coton industries since 1996. His deep knowledge of production systems enables him to streamline processes and enhance efficiency. With his experience, our team embraces a seamless production approach that drives operational excellence. Nitesh's expertise ensures our products meet the highest standards of quality and performance.

Nimesh Panara - Production Department

Nimesh Panara has been connected with the ceramic industry since 2008. With his keen eye for detail and a commitment to ensuring superior product quality, Nimesh brings valuable insights to the table. He has also served as a quality inspector at Somany Ceramics for 4 years and took on the role of a production engineer at Vintage Ceramic. His thorough understanding of production processes and quality control measures ensures our products are crafted with precision and care.

Mayank Vadaviya - Production Department

Mayank Vadaviya, the newest addition to our team, brings a fresh perspective to the sanitaryware industry. With a B.Sc. in Chemistry, he has a strong foundation in the scientific aspects of production. As a member of our quality department at Holo Sanitary Wares Pvt. Ltd., Mayank plays a vital role in ensuring that our products meet the highest standards of excellence. His innovative approach and dedication to quality make him an asset to our team.

A Classic Bathware *Collection*

■
GERMAN TECHNOLOGY



german kiln



CONTENT TABLE

ONE PCS CLOSET Pag. → **12**

WALL HUNG CLOSET Pag. → **22**

BACK TO WALL CLOSET Pag. → **30**

ONE PCS BASIN FULL Pag. → **34**

ONE PCS BASIN HALF Pag. → **36**

TABLE TOP BASIN Pag. → **38**

ACCESSORIES Pag. → **73**

WALL MOUNTED BASIN Pag. → **52**

FULL PEDESTAL BASIN Pag. → **60**

HALF PEDESTAL BASIN Pag. → **66**

EWC Pag. → **70**

SG. PAN Pag. → **72**

URINAL Pag. → **74**

INSTALLATION Pag. → **76**

Wall Hung

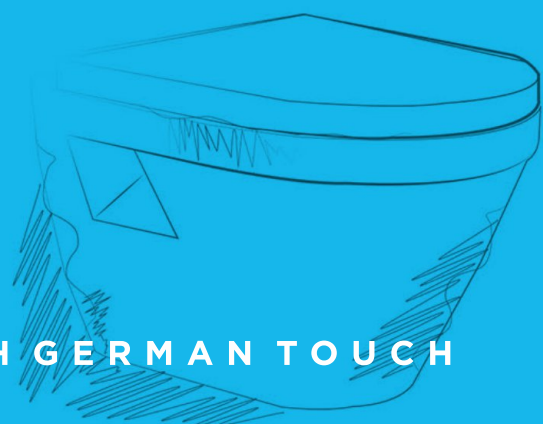

One Piece Closet

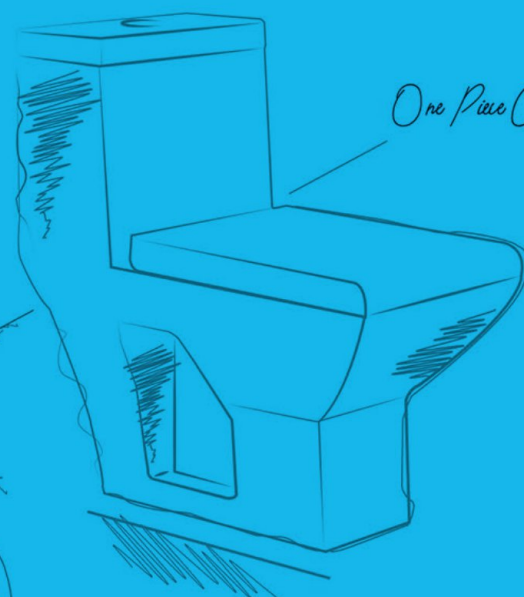

WITH GERMAN TOUCH

Table Top

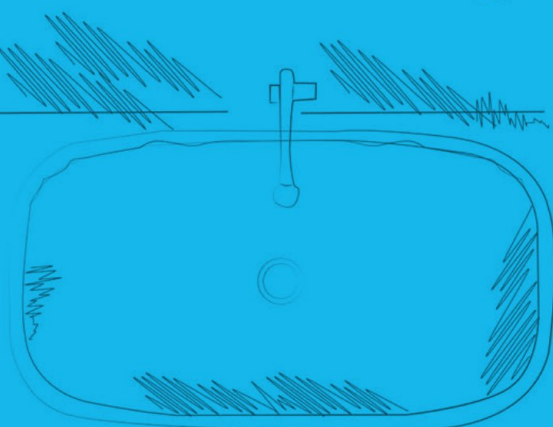

7
RIMLESS
CLOSET



SYPHONIC
SYSTEM



IN BUILT
JET SPRAY

FEATURES



ECO
FRIENDLY



GERMAN
TECHNOLOGY



EASY
TO INSTALL



TAKE-OF
SYSTEM



WATER
SAVING



STAIN FREE



SOFT CLOSE



HYGIENIC



EASY TO CLEAN

Sanitary Ware
Designed With
GERMAN TOUCH

HOLO
SANITARY WARE

WITH GERMAN TOUCH

▶
INTRODUCING
WATER SAVING CONCEPT

ONE PIECE Closet



ARNOVA 1001

S-Trap 225mm, P-Trap 180mm
670 x 350 x 760mm

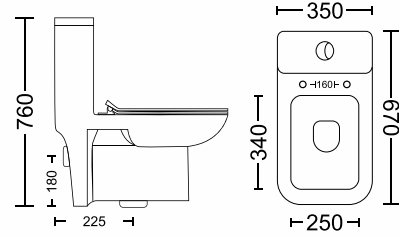

ELEKA 1004

S-Trap 225mm, P-Trap 180mm
650 x 345 x 750mm

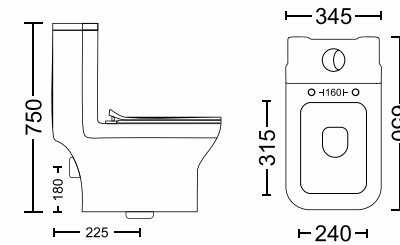

MARIUS 1002

S-Trap 225mm, P-Trap 180mm
625 x 345 x 745mm

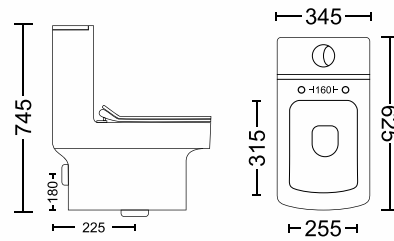

DUPON 1005

S-Trap 225mm, P-Trap 180mm
710 x 370 x 685mm

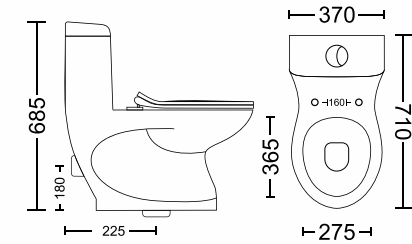

KONAD 1003

S-Trap 225mm, P-Trap 180mm
640 x 355 x 765mm

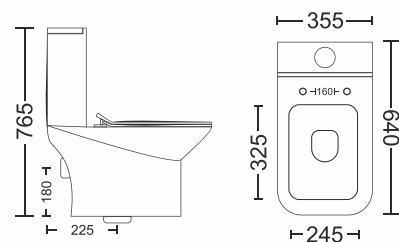

PLATERO 1006

S-Trap 225mm, P-Trap 180mm
675 x 370 x 740mm

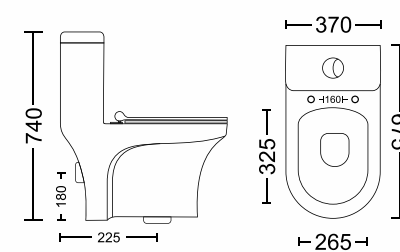

ONE PIECE Closet



MELCHOR 1007

S-Trap 225mm, P-Trap 180mm
665 x 365 x 725mm

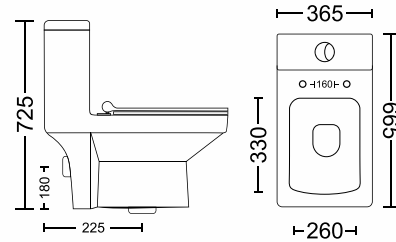

COLTON 1010

S-Trap 225/300mm, P-Trap 180mm
660 x 345 x 750mm

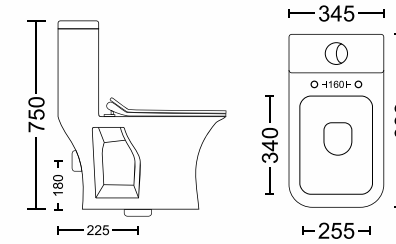

HELSTON 1008

S-Trap 225mm, P-Trap 180mm
660 x 345 x 740mm

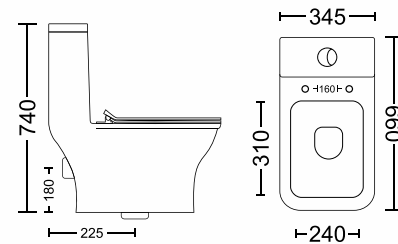

EASTON 1011

S-Trap 225mm, P-Trap 180mm
655 x 360 x 735mm

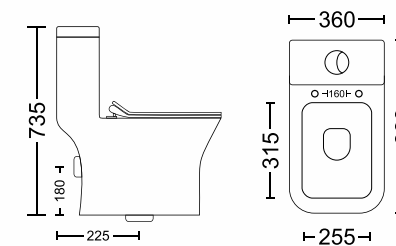

AGOSTO 1009

S-Trap 225mm, P-Trap 180mm
665 x 340 x 755mm

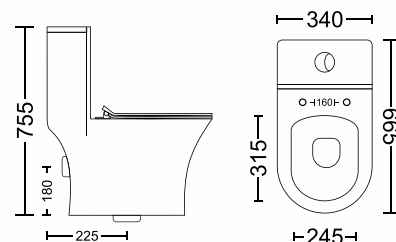

ANTONO 1012

S-Trap 225/300mm, P-Trap 180mm
660 x 360 x 750mm

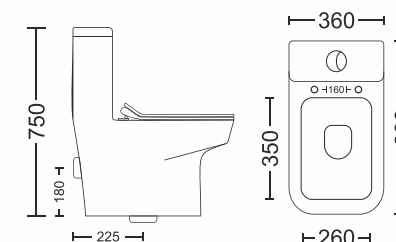



CAMILIA 1013

S-Trap 225/300mm, P-Trap 180mm
670 x 380 x 745mm

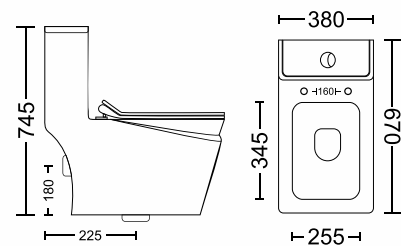

INAYA 1016

S-Trap 225/300mm, P-Trap 180mm
670 x 390 x 730mm

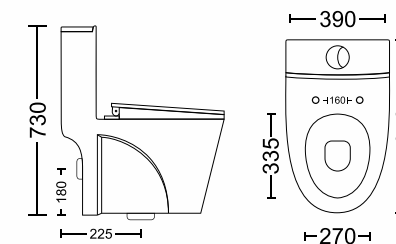

SKYLAR 1014

S-Trap 225mm, 300mm, P-Trap 180mm
665 x 350 x 755mm

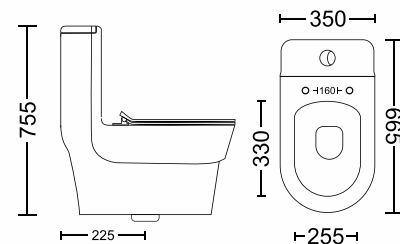

SPECTO 1017

S-Trap 225mm
650 x 345 x 735mm

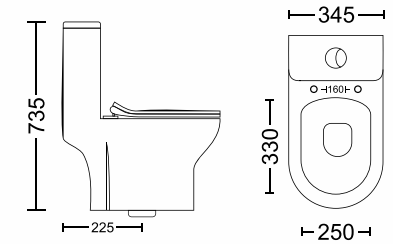

CARMON 1015

S-Trap 300, 225, 100mm, P-Trap 180mm
660 x 360 x 730mm

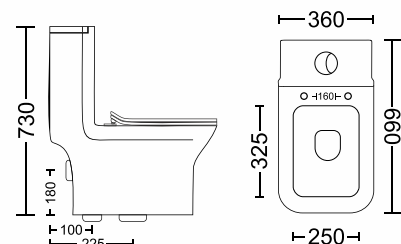

MENTOS 1018

S-Trap 225mm, P-Trap 180mm
670 x 350 x 740mm

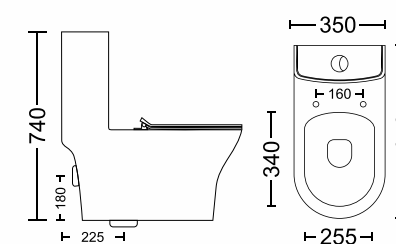

ONE PIECE Closet



BENITO 1101

S-Trap 225mm / 300mm
665 x 350 x 750mm

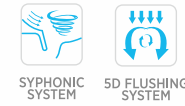
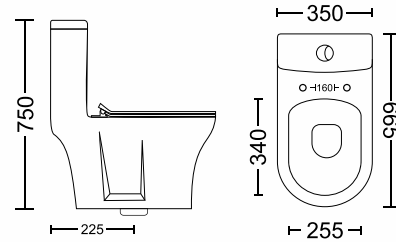

MAGNUS 1104

S-Trap 195mm, 300mm
665 x 375 x 760mm

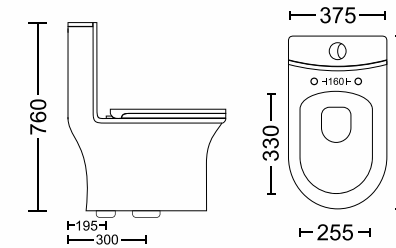

TIMEO 1102

S-Trap 225mm
680 x 350 x 770mm

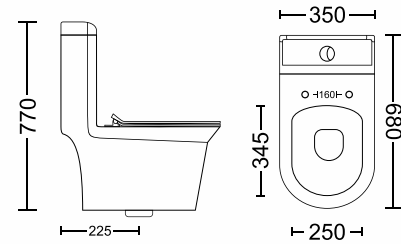
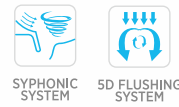

MAXIMUS 1105

S-Trap 225mm
660 x 400 x 670mm

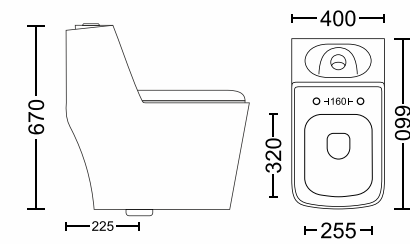

MARION 1103

S-Trap 225mm / 300mm
670 x 360 x 740mm

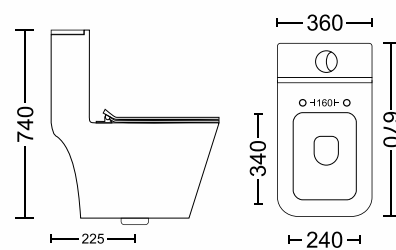

JULIUS 1106

S-Trap 225mm, 300mm
690 x 380 x 670mm

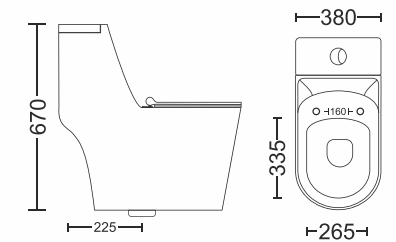

**WALL HUNG CLOSET
COLLECTION**



Sanitary Ware
Designed With



GERMAN TOUCH

WITH GERMAN TOUCH



INTRODUCING
WATER SAVING CONCEPT



WALL HUNG Closet

JUSPER 2001

565 x 370 x 355mm

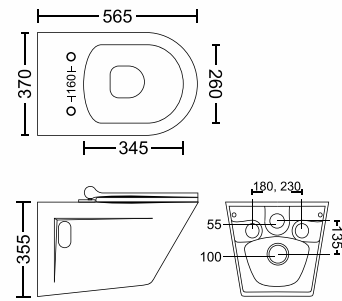

STIENS 2002

525 x 340 x 340mm

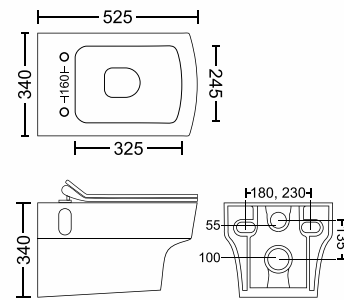

MEDOX 2004

520 x 370 x 350mm

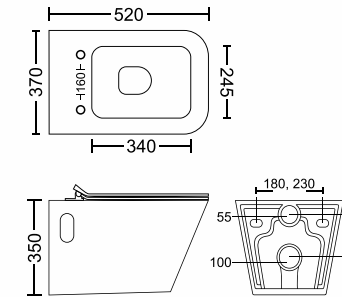

ENGIMATIC 2005

530 x 360 x 360mm

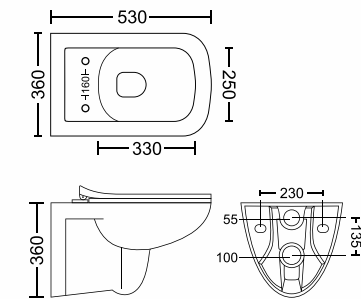

MARSHILA 2003

540 x 365 x 380mm

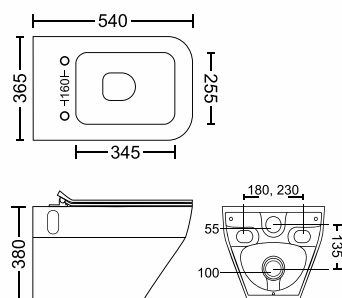

QBIX 2006

535 x 350 x 355mm

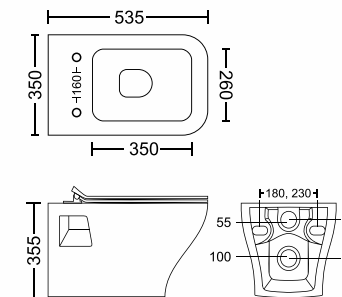



ENGIMA 2007

520 x 335 x 350mm



IN BUILT
JET SPRAY

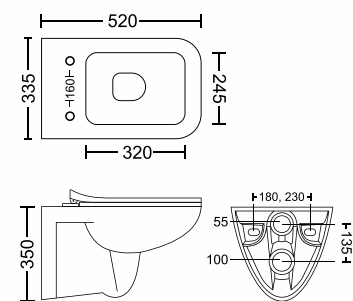

WINTA 2010

485 x 355 x 360mm



IN BUILT
JET SPRAY



RIMLESS
CLOSET

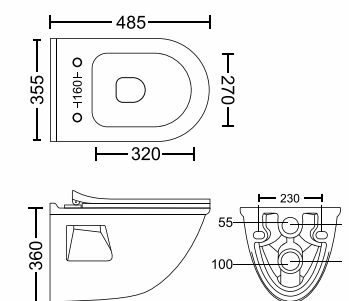

ARMIDA 2008

545x 355 x 350mm

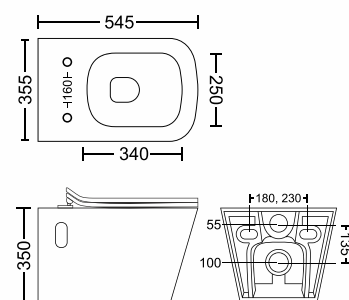

ESTA 2011

525 x 360 x 370mm

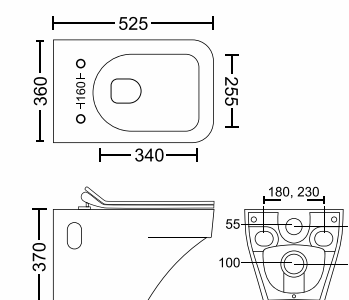

TRACY 2009

485x 365 x 365mm



IN BUILT
JET SPRAY



RIMLESS
CLOSET

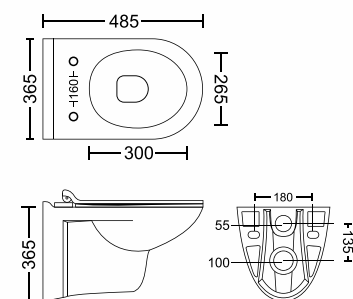

TIPIT 2012

570 x 370 x 370mm



RIMLESS
CLOSET

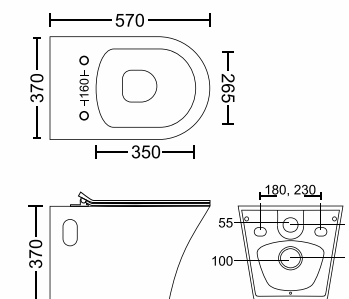

WALL HUNG Closet



ROXAN 2013
510 x 350 x 360mm

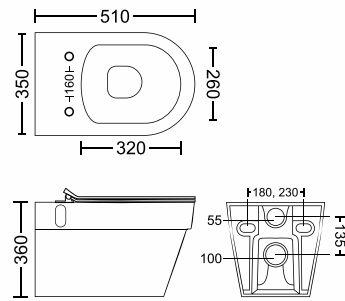

ORAN 2016
520 x 360 x 360mm

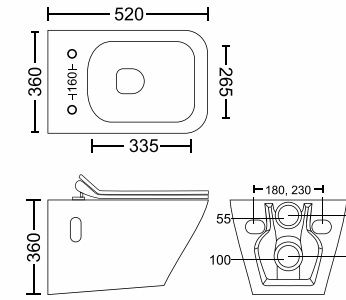

EMICA 2014
530 x 365 x 360mm

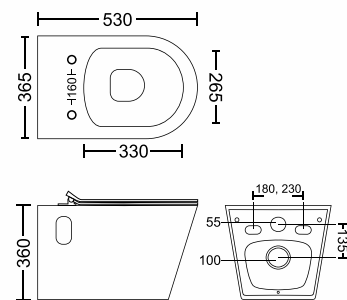

ALICE 2017
540 x 360 x 390mm

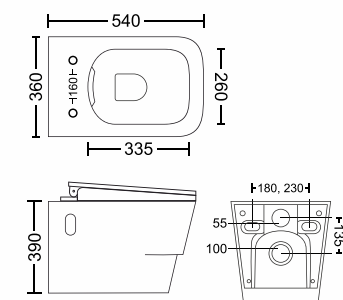

POLAR 2015
535 x 350 x 360mm

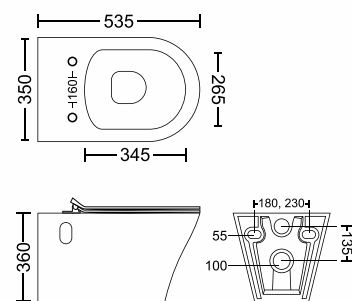

RIO 2018
505 x 360 x 335mm

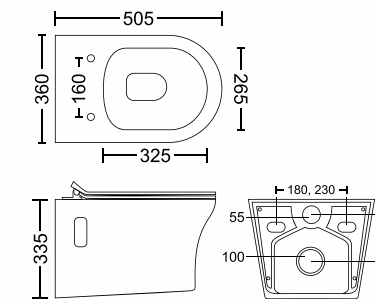

BACK TO WALL CLOSET COLLECTION

WITH GERMAN TOUCH



INTRODUCING
WATER SAVING CONCEPT

A back to wall toilet is installed directly onto a supportive wall meaning that all plumbing and waste pipes can flow straight into the wall making it hidden from view. The cistern can be concealed by a back to wall unit or within the wall itself making for better aesthetics and saving space

BACK TO WALL Closet



HEMRIK 2101

S-Trap 100mm
530 x 355 x 410mm

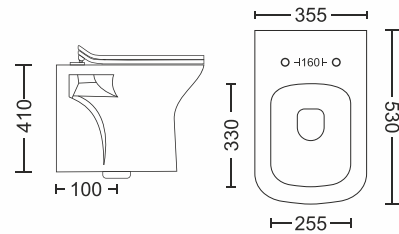

ANKAN 2104

S-Trap 100mm, P-Trap 180mm
550 x 375 x 415mm

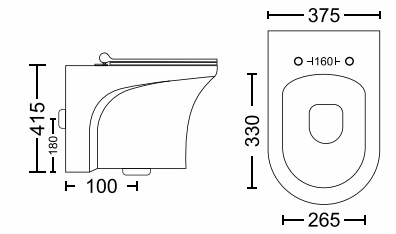

HEXEL 2102

S-Trap 100mm, P-Trap 180mm
540x 360 x 405mm

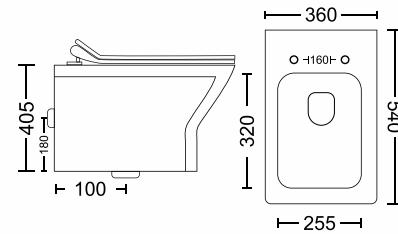

SINTRA 2105

S-Trap 100mm, P-Trap 180mm
565 x 355 x 400mm

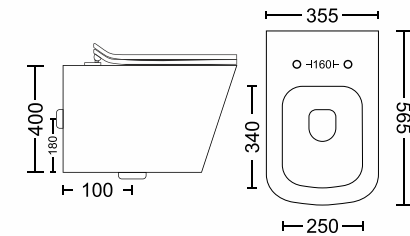

WELZIN 2103

S-Trap 100mm, P-Trap 180mm
550 x 350 x 410mm

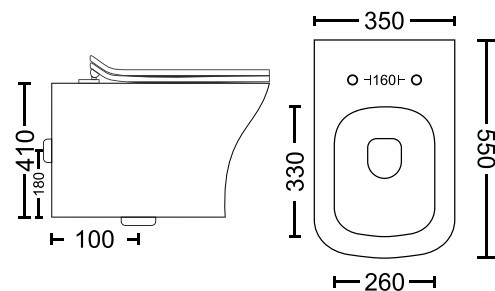

BIDET 2151

550 x 350 x 410mm

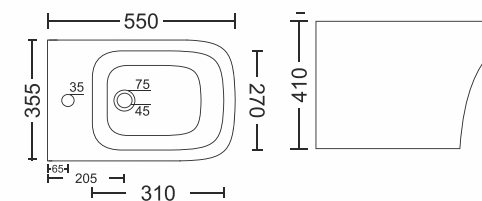

ONE PCS FULL Basin

ROSEN 3001
455 x 455 x 860 mm

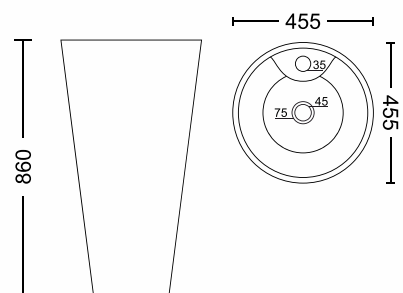

HOLO
SANITARY WARE



BERG 3002
530 x 445 x 880mm

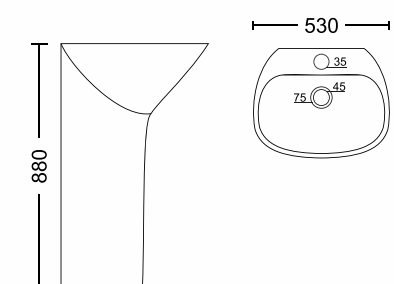

BOLSA 3003
470 x 425 x 855mm

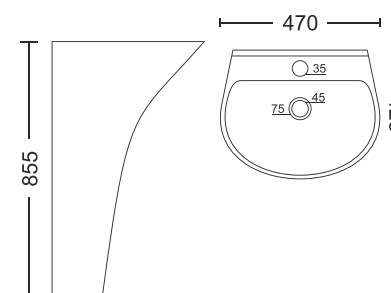

ONE PCS HALF Basin

NICOLAS 3101

500 x 405 x 355mm
20 x 16 Inch (Approx)

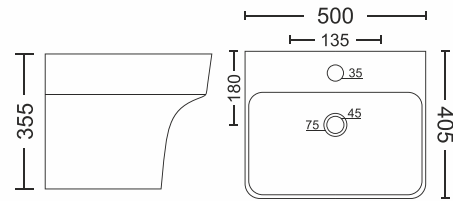

JIM 3104

500 x 410 x 380mm
20 x 16 Inch (Approx)

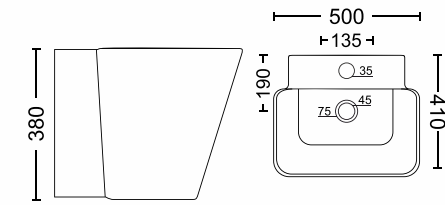

ETHAN 3102

475 x 425 x 360mm
19 x 17 Inch (Approx)

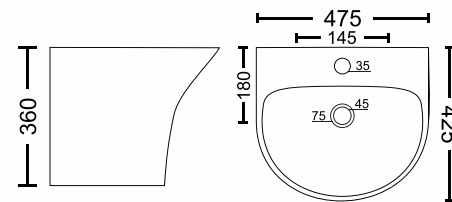

MECO 5001

520 x 400 x 200mm
21 x 16 Inch (Approx)

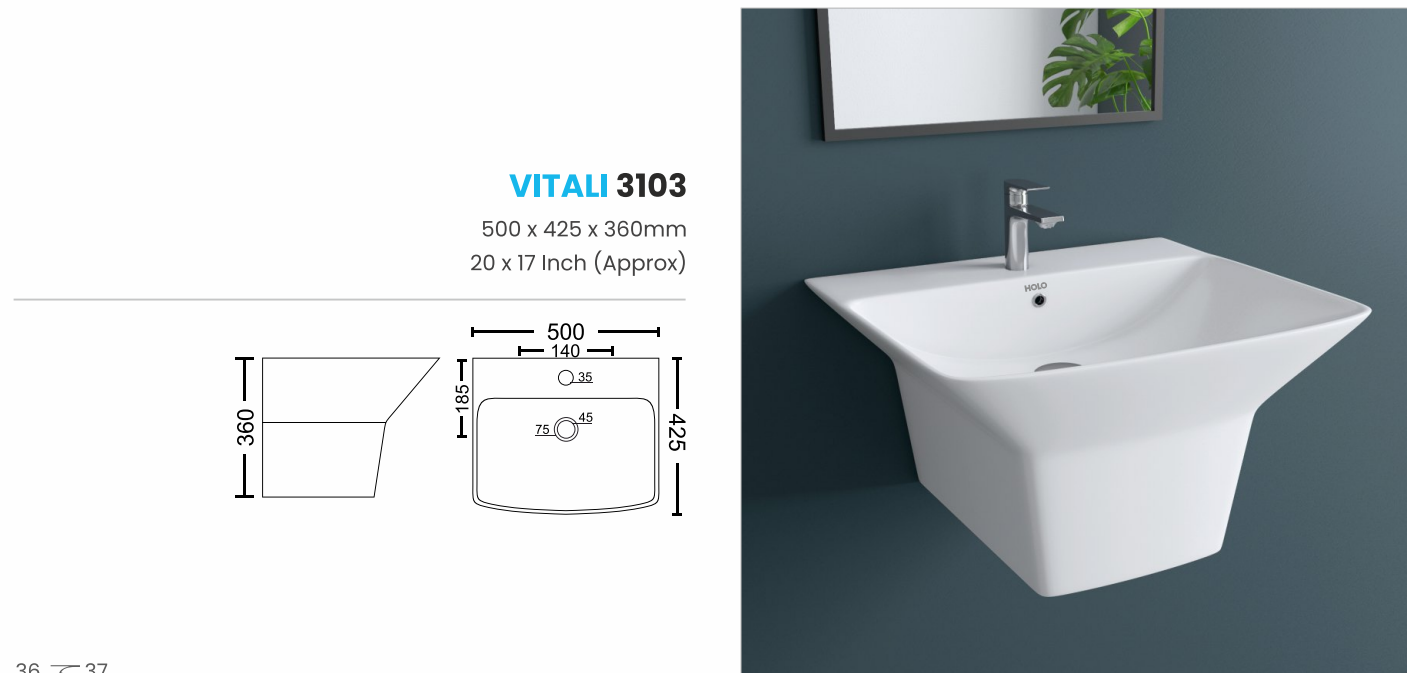
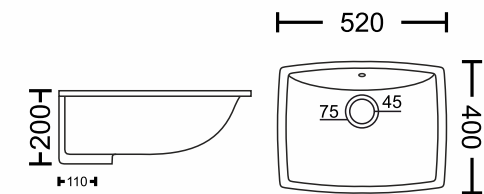

VITALI 3103

500 x 425 x 360mm
20 x 17 Inch (Approx)

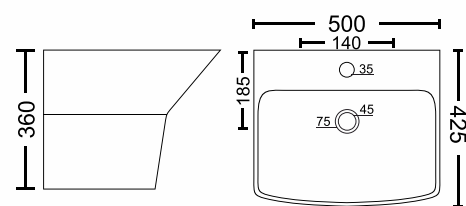

ZUCA 5002

520 x 370 x 200mm
21 x 15 Inch (Approx)

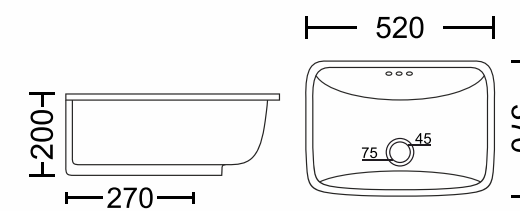



TABLE TOP BASIN COLLECTION

A range of ceramic basins in an exquisite rectangular design with smooth edges brings a purely contemporary edge to the entire bathroom.

TABLE TOP Basin

ELINE 7001

415 x 345 x 165mm
16 x 14 Inch (Approx)

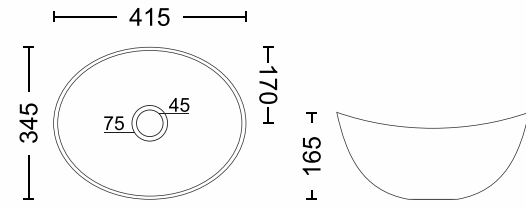

FONZA 7004

480 x 390 x 150mm
19 x 15 Inch (Approx)

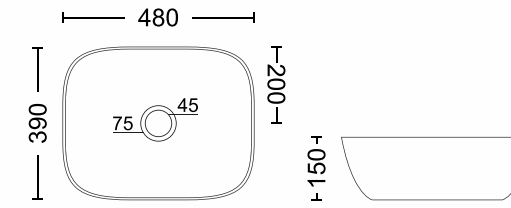

ALONY 7002

405 x 340 x 145mm
16 x 13 Inch (Approx)

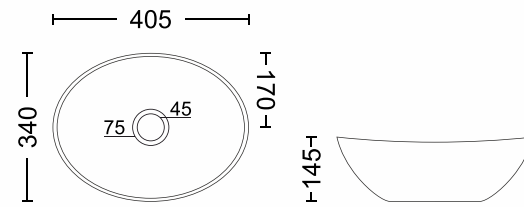

HEMIS 7005

550 x 360 x 125mm
22 x 14 Inch (Approx)

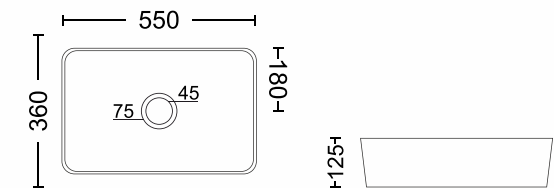

LONZA 7003

460 x 335 x 135mm
18 x 13 Inch (Approx)

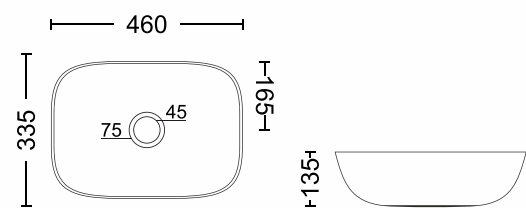

JOMO 7006

420 x 415 x 140mm
16 x 16 Inch (Approx)

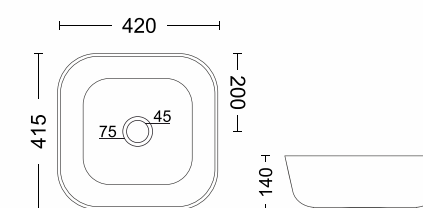



GARNEL 7007

480 x 365 x 130mm
19 x 14 Inch (Approx)

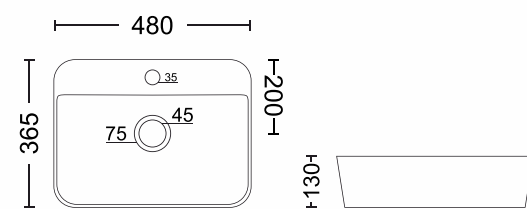

FEDI 7010

390 x 390 x 140mm
15 x 15 Inch (Approx)

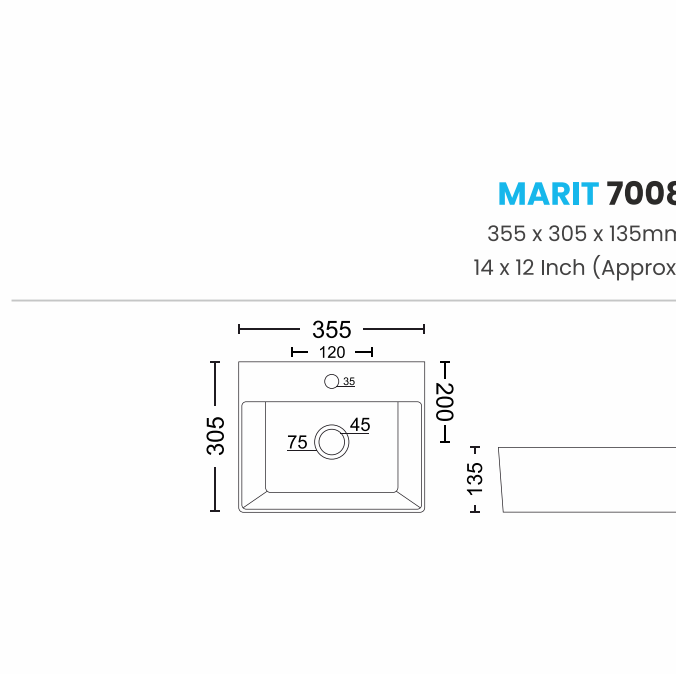
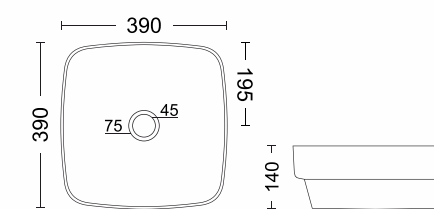

MARIT 7008

355 x 305 x 135mm
14 x 12 Inch (Approx)

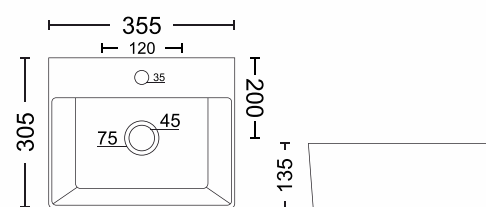

CARLIN 7011

520 x 355 x 115mm
21 x 14 Inch (Approx)

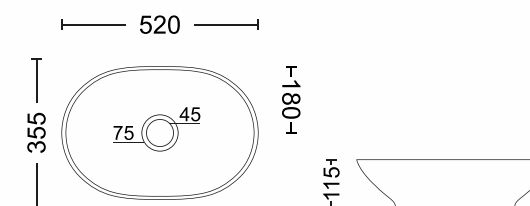

RENOSA 7012

500 x 380 x 130mm
20 x 15 Inch (Approx)

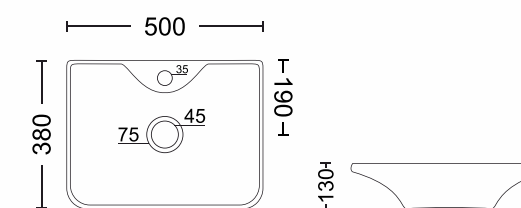

THOBHAN 7009

615 x 360 x 115mm
24 x 14 Inch (Approx)

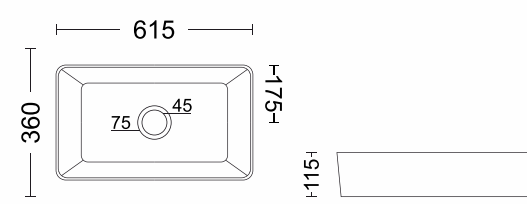
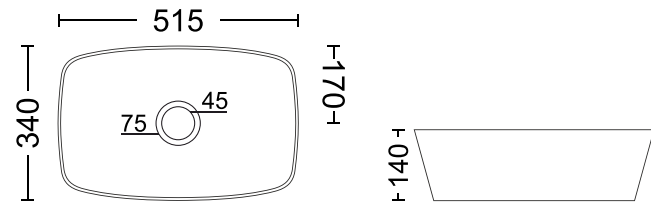

TABLE TOP Basin

COLIMA 7013

515 x 340 x 140mm
20 x 14 Inch (Approx)



TEPIS 7016

635 x 395 x 145mm
25 x 16 Inch (Approx)

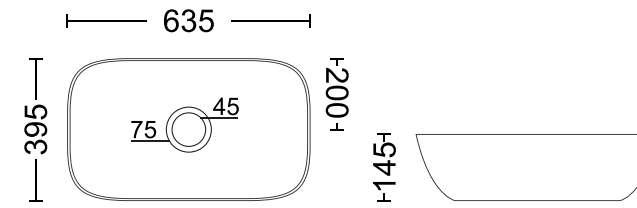

TRIV 7014

605 x 365 x 150mm
24 x 14 Inch (Approx)

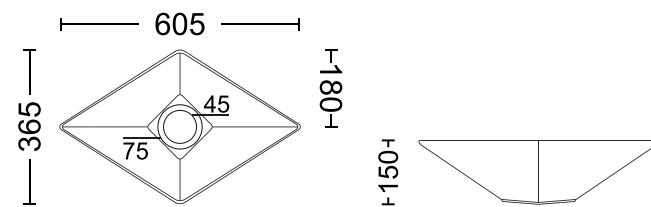

TED 7017

410 x 410 x 140mm
16 x 16 Inch (Approx)

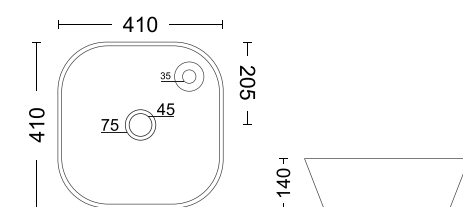

LUBEK 7015

545 x 355 x 135mm
21 x 14 Inch (Approx)

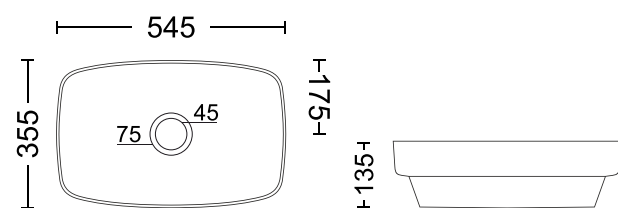

FLAKE 7018

425 x 420 x 140mm
17 x 17 Inch (Approx)

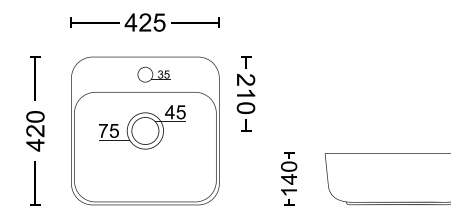

EXELON 7019

525 x 365 x 130mm
21 x 14 Inch (Approx)

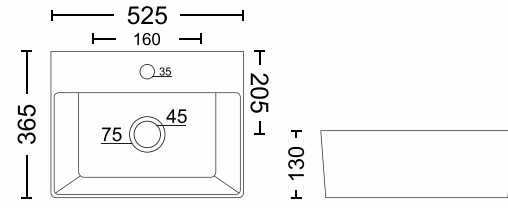

DEVON 7022

455 x 390 x 120mm
18 x 15 Inch (Approx)

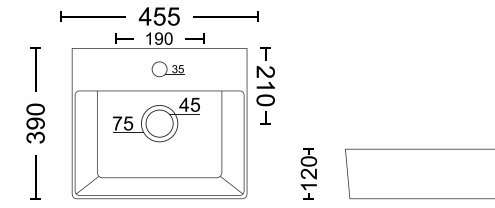

FEDEX 7020

600 x 370 x 135mm
24 x 15 Inch (Approx)

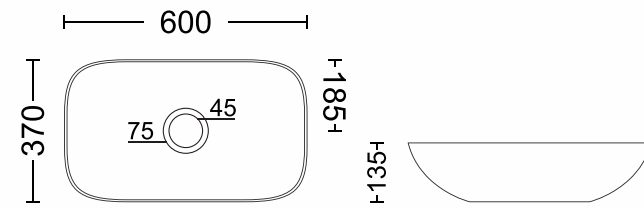

NUCAR 7023

550 x 350 x 145mm
22 x 14 Inch (Approx)

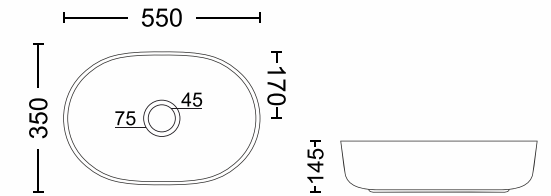

CRYA 7021

425 x 330 x 130mm
17 x 13 Inch (Approx)

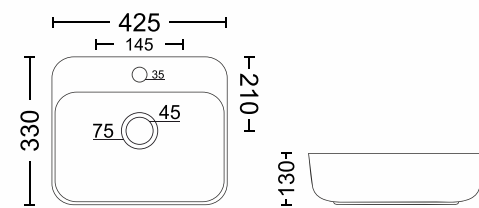

SOLI 7024

395 x 395 x 145mm
16 x 16 Inch (Approx)

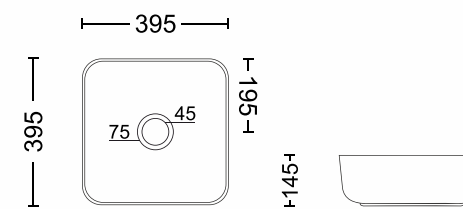



MARKEL 7025

705 x 385 x 140mm
28 x 15 Inch (Approx)

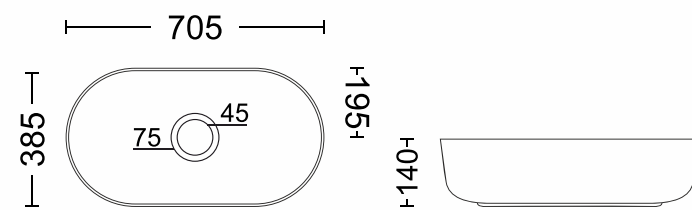

AKIRA 7026

430 x 430 x 125mm
17 x 17 Inch (Approx)

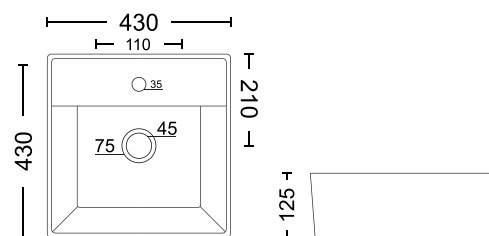

MACK 7027

495 x 385 x 150mm
20 x 15 Inch (Approx)

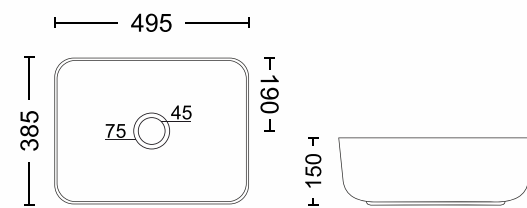

KUMA 7028

455 x 355 x 130mm
18 x 14 Inch (Approx)

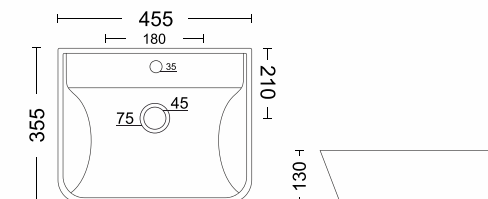



DOVER 7029
600 x 400 x 145mm
24 x 16 Inch (Approx)

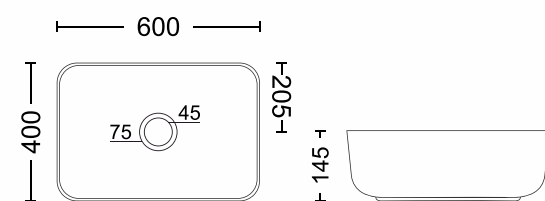

ERICH 7031

520 x 405 x 160mm
20 x 16 Inch (Approx)

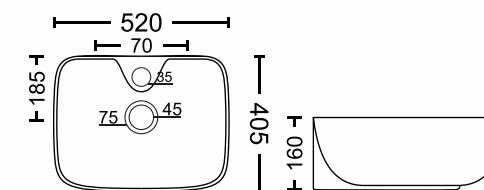

LIVIA 7030
505 x 380 x 125mm
20 x 15 Inch (Approx)

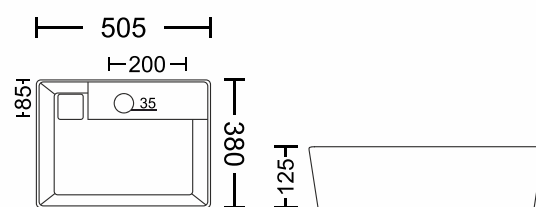



HARTWIN 7032

555X360X140mm
22X16 Inch (Approx)

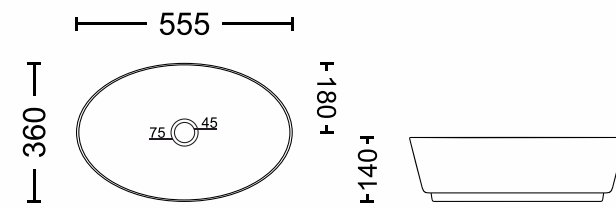

MAX 7035

360X260X115mm
14X10 Inch (Approx)

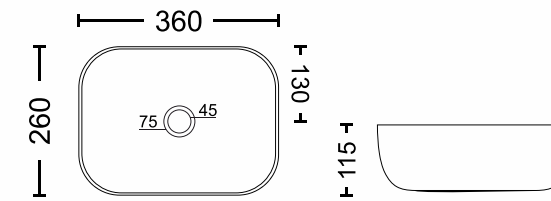

PAUL 7033

575X405X140mm
23X16 Inch (Approx)

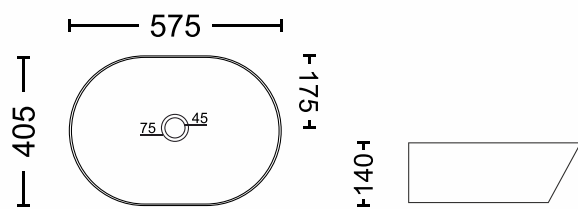

FELIX 7036

400X400X160mm
16X16 Inch (Approx)

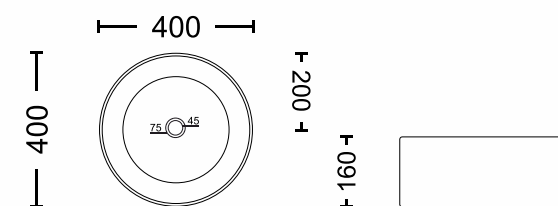

OTTO 7034

415X310X135mm
16X12 Inch (Approx)

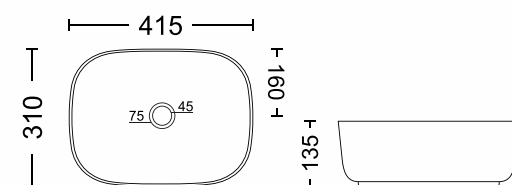

HARRY 7037

400X400X160mm
16X16 Inch (Approx)

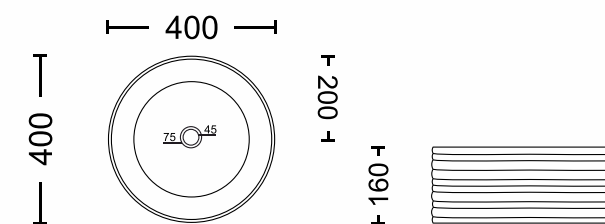

WALL MOUNTED Basin

PANARI 4001

485 x 320 x 190mm
19 x 13 Inch (Approx)

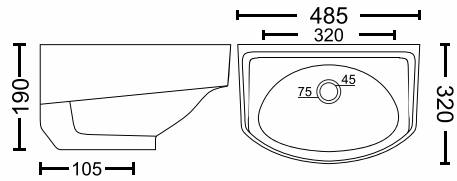

AVENA 4004

350 x 345 x 145mm
14 x 14 Inch (Approx)

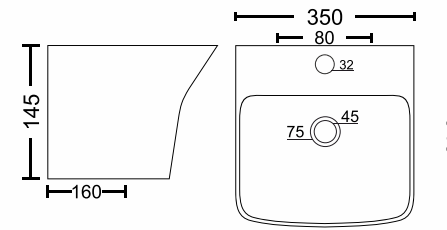

TUSCON 4002

480 x 360 x 180mm
19 x 14 Inch (Approx)

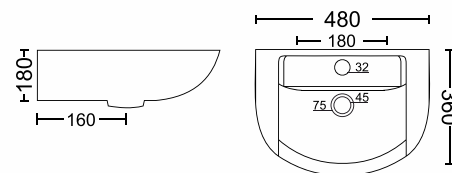

CELIO 4005

575 x 460 x 190mm
23 x 18 Inch (Approx)

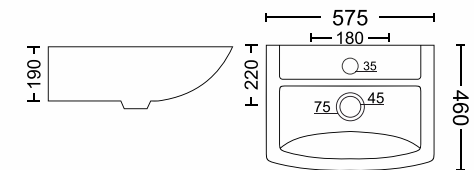

ARMIS 4003

340 x 360 x 145mm
13 x 14 Inch (Approx)

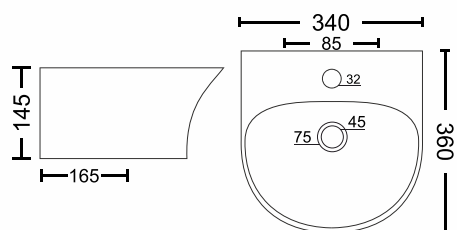

WALTER 4006

525 x 420 x 210mm
21 x 17 Inch (Approx)

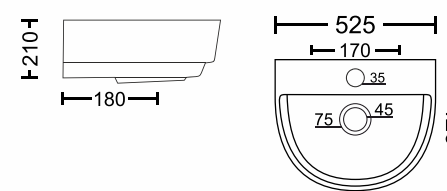

WALL MOUNTED
Basin

OTIS 4007

360 x 425 x 135mm
14 x 17 Inch (Approx)

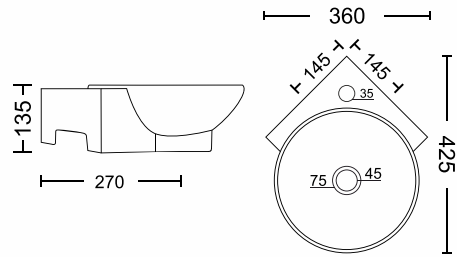

MORENA 4009

580 x 420 x 190mm
23 x 17 Inch (Approx)

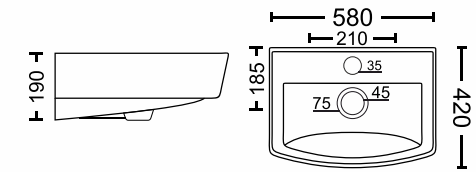

KALISTO 4010

560 x 415 x 200mm
22 x 16 Inch (Approx)

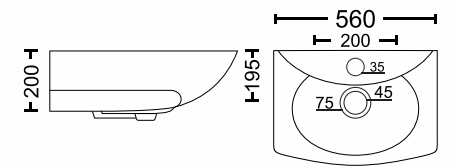

GIONA 4008

465 x 380 x 190mm
18 x 15 Inch (Approx)

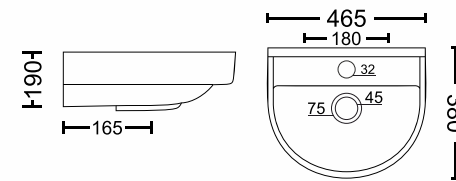

ELVINO 4011

460 x 465 x 200mm
18 x 18 Inch (Approx)

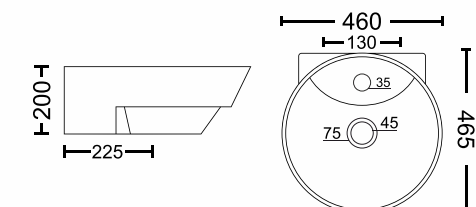

WALL MOUNTED Basin

ELDORA 4012

630 x 485 x 220mm
25 x 19 Inch (Approx)

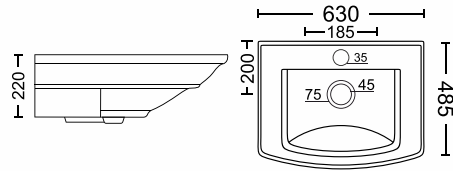

KELI 4013

360 x 365 x 145mm
14 x 14 Inch (Approx)

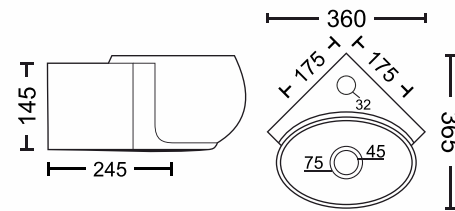

PERU 4016

420 x 290 x 190mm
16 x 12 Inch (Approx)

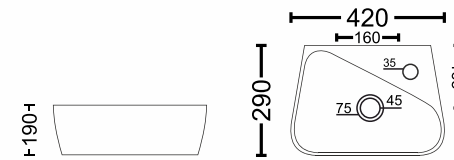

AXA 4015

580 x 405 x 190mm
23 x 16 Inch (Approx)

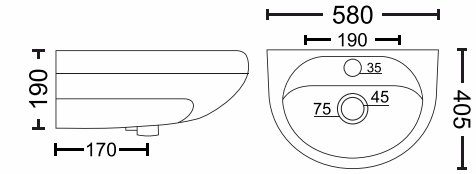

CALEB 4014

505 x 405 x 160mm
20 x 16 Inch (Approx)

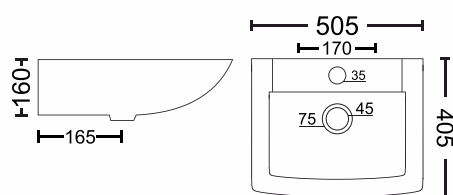

CONRAD 4017

465 x 365 x 180mm
18 x 14 Inch (Approx)

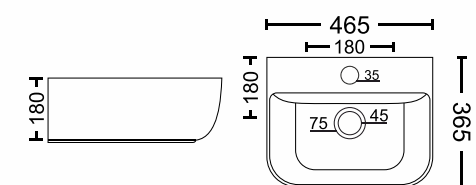

WALL MOUNTED
Basin

CLAUS 4018

470 x 365 x 150mm
18 x 14 Inch (Approx)

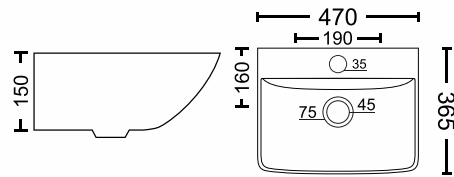

EVA 4020

385 x 305 x 175mm
15 x 12 Inch (Approx)

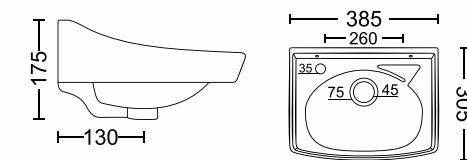

ROLF 4019

410 x 320 x 145mm
16 x 13 Inch (Approx)

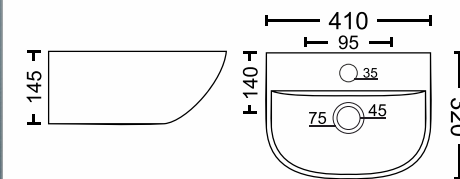

ELKE 4021

515 x 420 x 195mm
20 x 16 Inch (Approx)

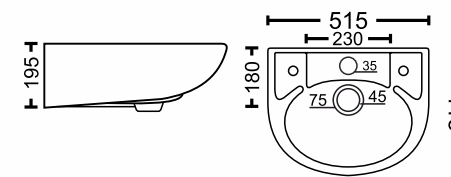

WALL MOUNTED
Basin

OSCAR 4022
470X360X150mm
18X14 Inch (Approx)

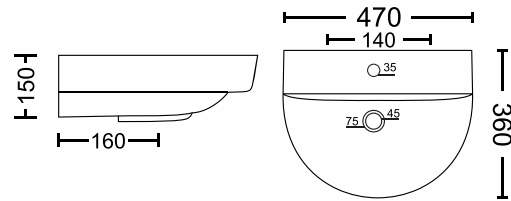

OLIVER 4024
510X410X205mm
20X16 Inch (Approx)

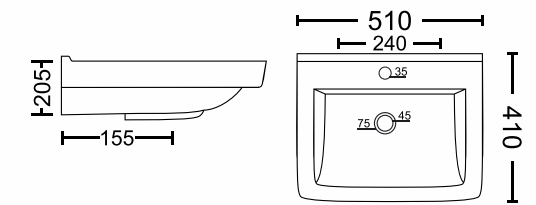

WILLIAM 4023
520X415X175mm
20X16 Inch (Approx)

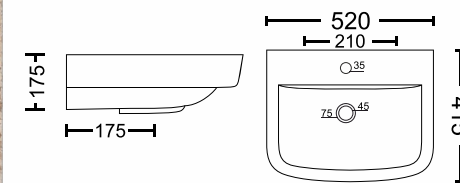

VIGGO 4025
410X365X150mm
16X14 Inch (Approx)

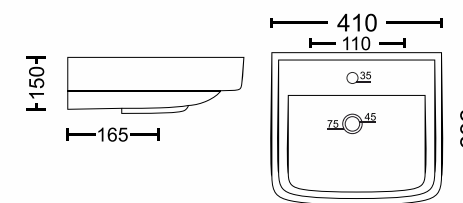

FULL PEDESTAL Basin

AVENA-BRUNO BWB 4004 + BPD 6004

350x345x820mm
14 x 14 Inch (Approx)

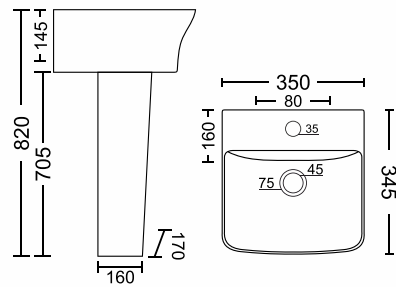

CELIO-LUCAS BWB 4005 + BPD 6002

575x460x855mm
23 x 18 Inch (Approx)

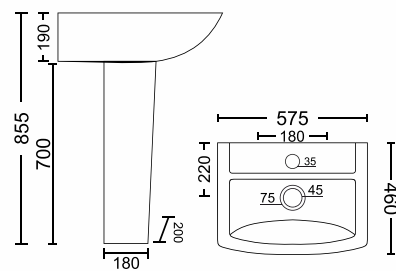

WALTER-OLIN BWB 4006 + BPD 6003

525x420x865mm
21 x 17 Inch (Approx)

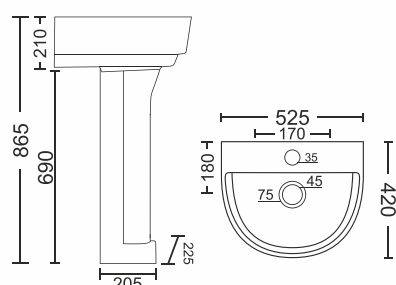

KALISTO-LUCAS BWB 4010 + BPD 6002

560x415x855mm
22 x 16 Inch (Approx)

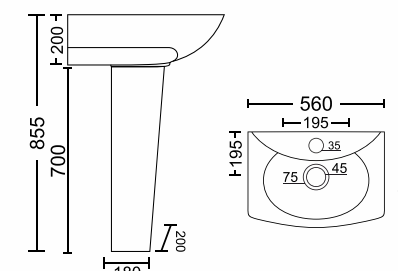

ELVINO-OLIN BWB 4011 + BPD 6003

460x465x850mm
18 x 18 Inch (Approx)

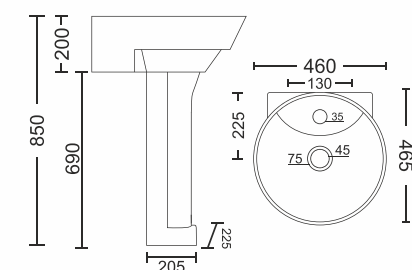

MORENA-LUCAS BWB 4009 + BPD 6002

580x420x845mm
23 x 17 Inch (Approx)

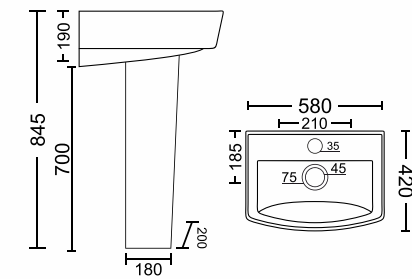

FULL PEDESTAL Basin

ELDORA-TORIN BWB 4012 + BPD 6001

630x485x880mm
25 x 19 Inch (Approx)

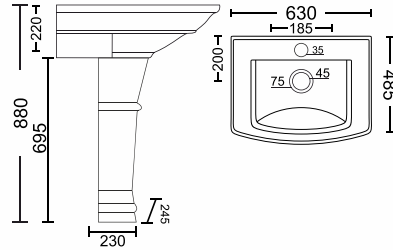

CALEB-LUCAS BWB 4014 + BPD 6002

510x405x825mm
20 x 16 Inch (Approx)

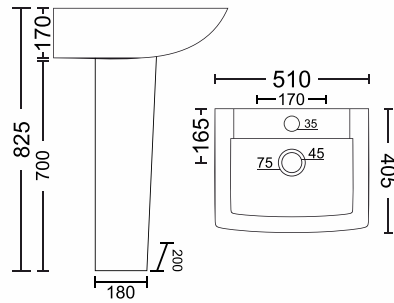

CLAUS-LUCAS BWB 4018 + BPD 6002

470 x 365 x 820mm
18 x 14 Inch (Approx)

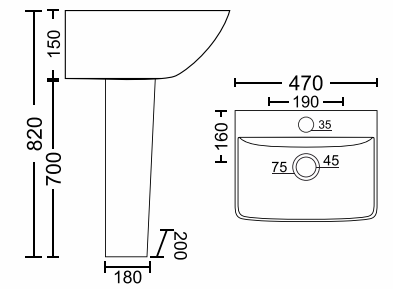

AXA-OLIN BWB 4015 + BPD 6003

580x405x845mm
23 x 16 Inch (Approx)

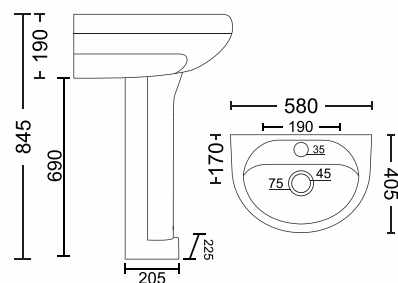

NEW!



ROLF-BRUNO BWB 4019 + BPD 6004

410x320x830mm
16 x 13 Inch (Approx)

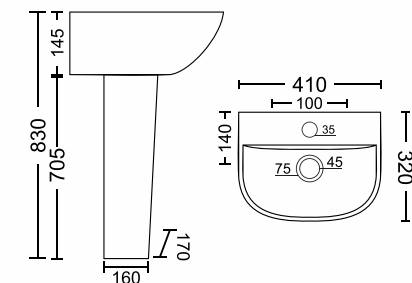

HOLO

SANITARY WARE

CONRAD-LUCAS BWB 4017 + BPD 6002

465x365x840mm
18 x 14 Inch (Approx)

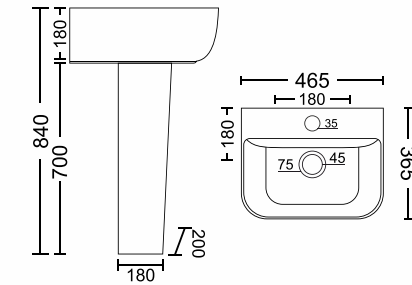

FULL PEDESTAL Basin

ELKE-OLIN
BWB 4021 + BPD 6003
515x420x830mm
20 x 16 Inch (Approx)

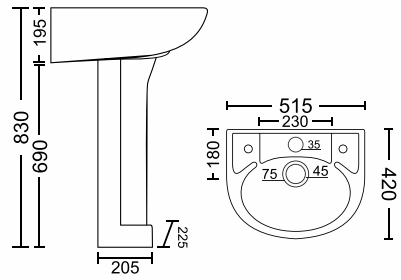

NEW!

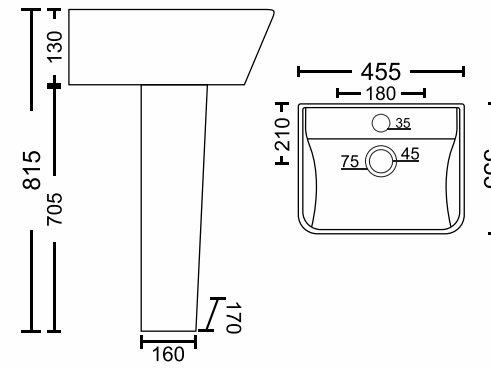

KUMA-BRUNO
BWB 7028 + BPD 6004
455x355x815mm
18 x 14 Inch (Approx)



NEW!



NEW!

MARIT-BRUNO
BWB 7008 + BPD 6004
355x305x815mm
14 x 12 Inch (Approx)

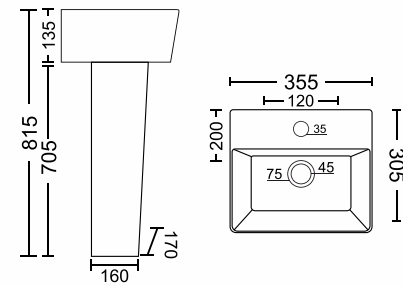

HALF PEDESTAL Basin

WALTER-ISLA
BWB 4006 + BPD 6102

525x420x470mm
21 x 17 Inch (Approx)

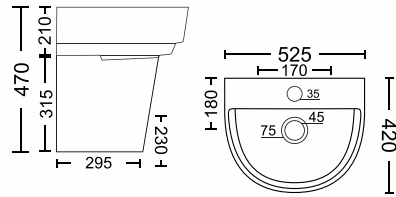

KALISTO-JELI
BWB 4010 + BPD 6103

560x415x500mm
22 x 16 Inch (Approx)

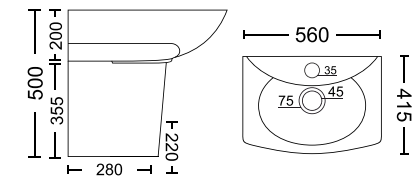

GIONA-NOA
BWB 4008 + BPD 6101

465x380x435mm
18 x 15 Inch (Approx)

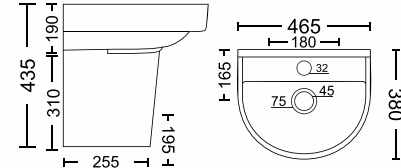

MORENA-JELI
BWB 4009 + BPD 6103

580x420x480mm
23 x 17 Inch (Approx)

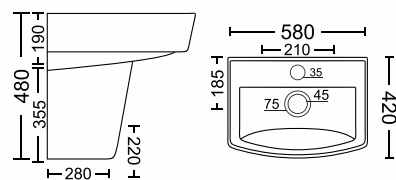

ELDORA-JELI
BWB 4012 + BPD 6103

630x485x525mm
25 x 19 Inch (Approx)

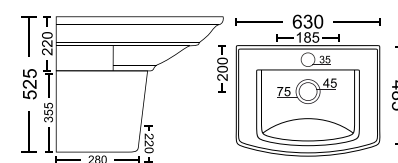

HALF PEDESTAL Basin

CONRAD-ISLA
BWB 4017 + BPD 6102

465x365x445mm
18 x 14 Inch (Approx)

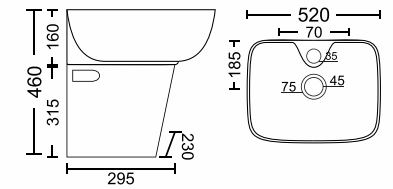
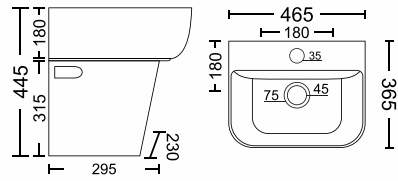

ERICH-ISLA
BWB 7031 + BPD 6102

520x405x460mm
20 x 16 Inch (Approx)



NEW!

KUMA-JELI
BWB 7028 + BPD 6103

455x355x465mm
18 x 14 Inch (Approx)

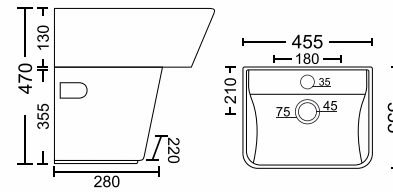

ANGLO-S 8101
585 x 480 x 405mm

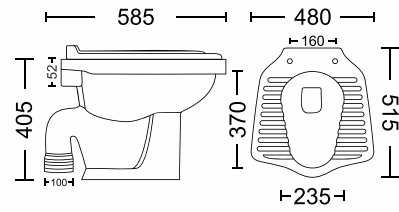

ANGLO-P 8102
575 x 480 x 390mm

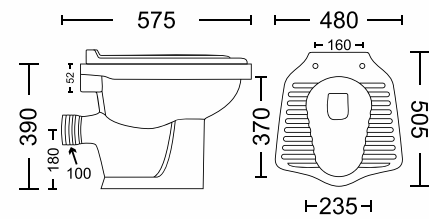

EWC-S 8103
550 x 365 x 420mm

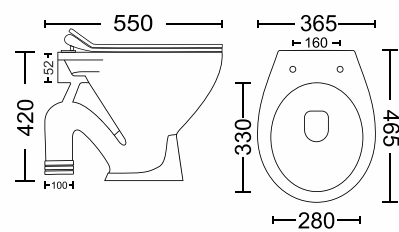

EWC-P 8104
540 x 365 x 420mm

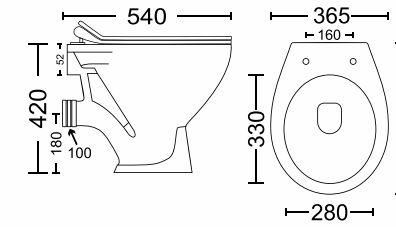

RECT 8105
555 x 335 x 410mm

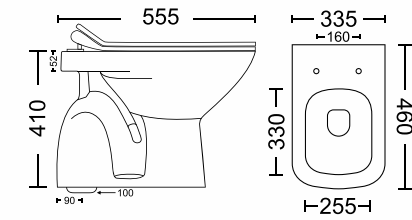

KEL 8106
565 x 365 x 415mm

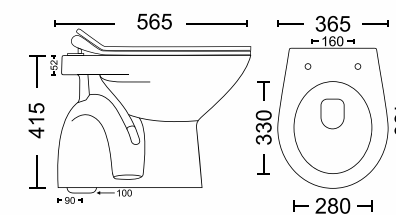

PAN

20" ORISSA PAN 8001

525 x 430 x 240 mm

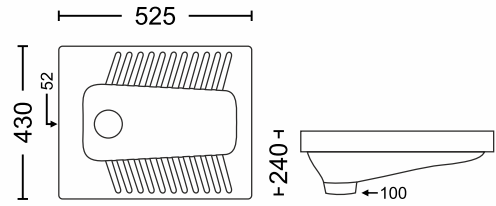

FEMALE URINAL POT

JESSEN 9006

490 x 380 x 110mm

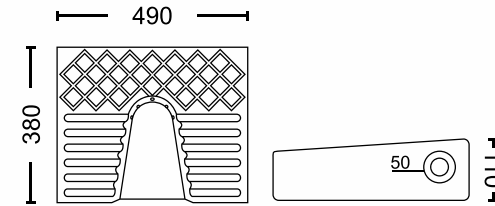

SQUARE SHAPE PAN



23" ORISSA PAN 8002

590 x 450 x 280 mm

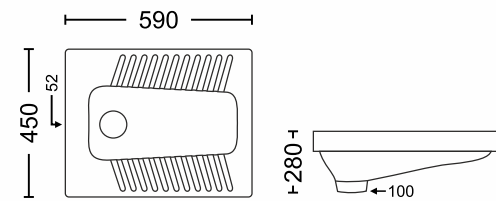

20" CITY PAN 8003

530 x 430 x 190 mm

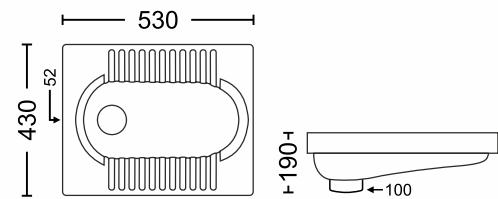

U.F. SEAT COVER



RAG BOLTS FOR WALL HUNG

ACCES-SORIES



P TRAP

P-TRAP BUNDLES ARE AVAILABLE IN PAPER PACKAING

URINAL

FEMI 9001

340 x 295 x 550mm

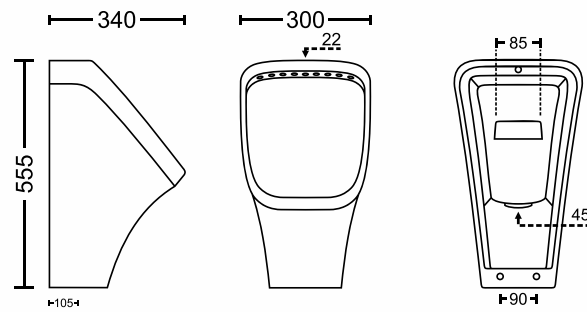

LARS 9003

290 x 285 x 405mm

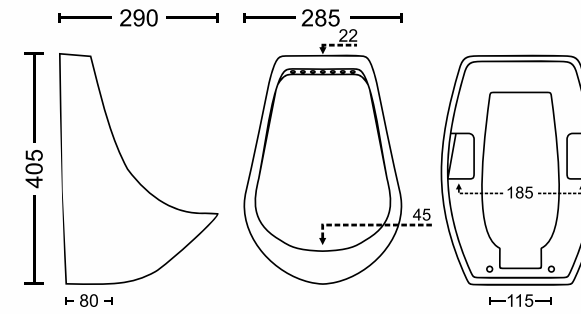

RONAM 9002

330 x 330 x 630mm

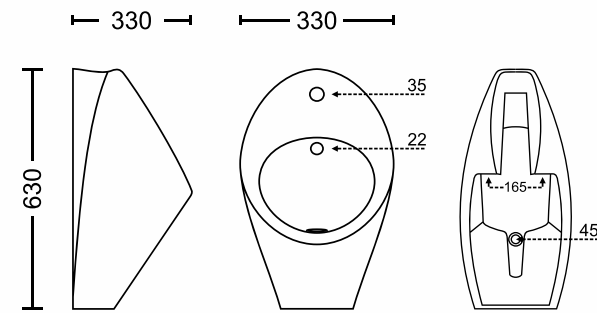

ROCIO 9004

315 x 325 x 565mm

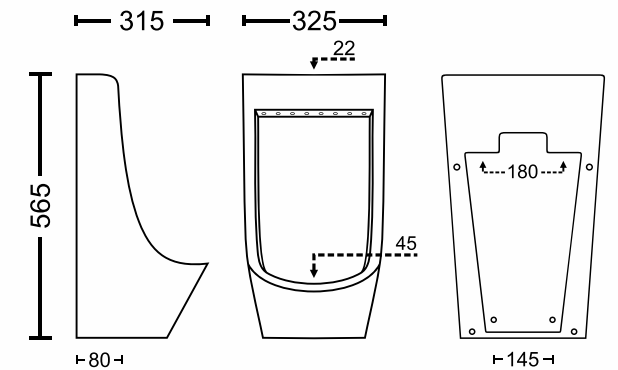

RONAM 9002

(GLOSSY/MATT-BLACK)

330 x 330 x 630mm

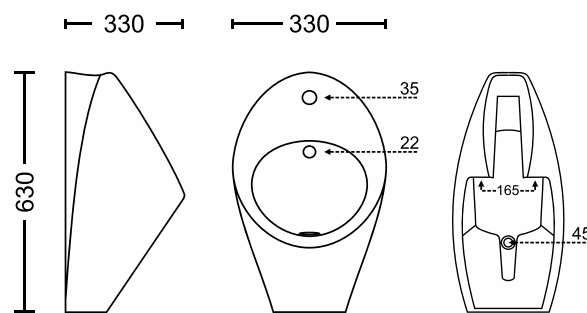

POOL 9005

255 x 330 x 410mm

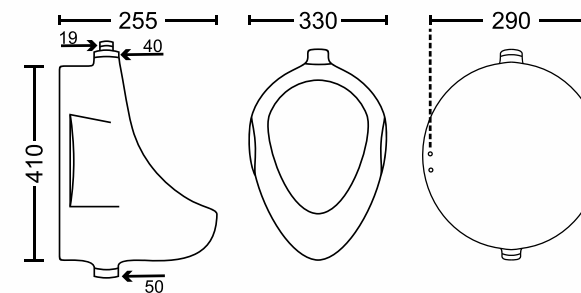

AGOSTO 1009

S-Trap 225mm, P-Trap 180mm
665 x 340 x 755mm



IN BUILT
JET SPRAY

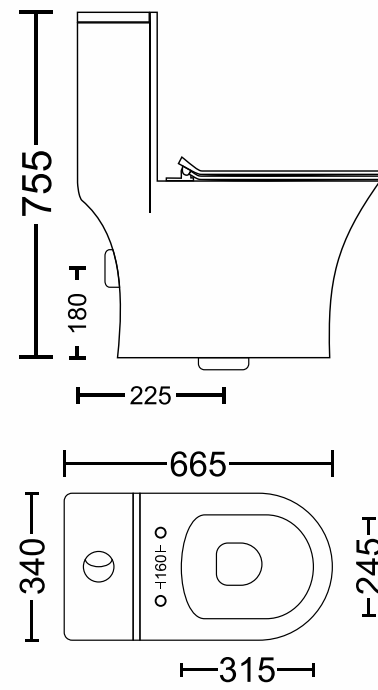

CAMILIA 1013

S-Trap 225/300mm, P-Trap 180mm
670 x 380 x 745mm



IN BUILT
JET SPRAY



RIMLESS
CLOSET

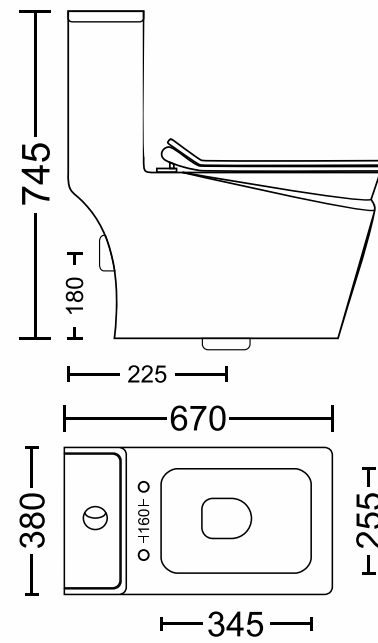

MENTOS 1018

S-Trap 225mm, P-Trap 180mm
670 x 350 x 740mm



IN BUILT
JET SPRAY



RIMLESS
CLOSET

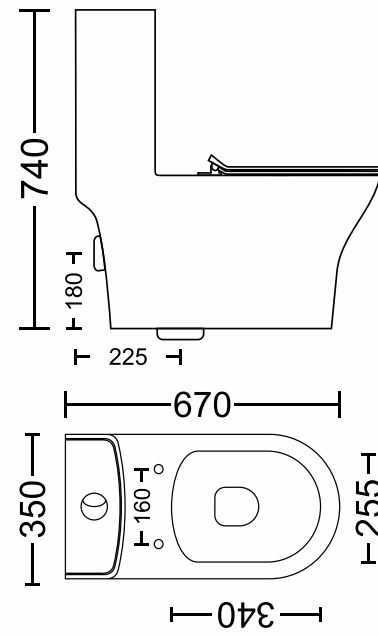

MEDOX 2004

520 x 370 x 350mm



IN BUILT
JET SPRAY



RIMLESS
CLOSET

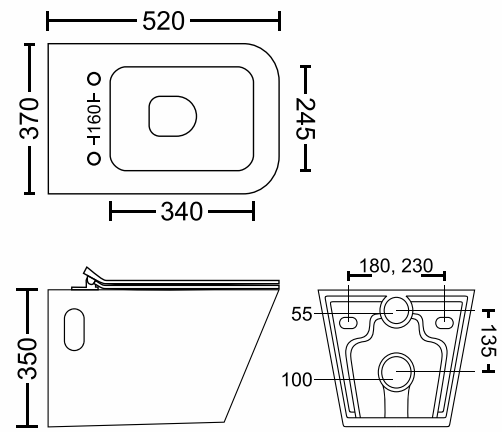

TIPIT 2012

570 x 370 x 370mm



RIMLESS CLOSET

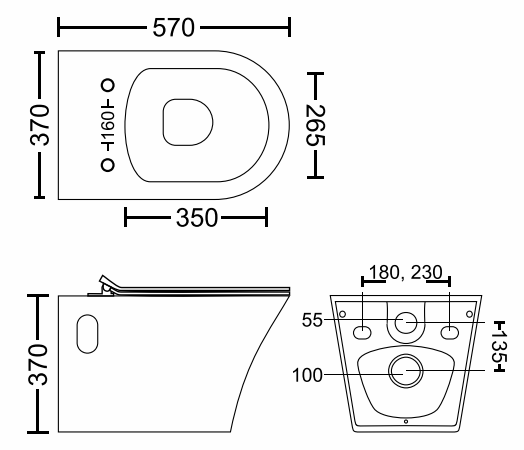

TABLE TOP
Color Series



FONZA 7004
Color : Grey
Finish : Glossy



FONZA 7004
Color : Grey
Finish : Matt



FONZA 7004
Color : Black
Finish : Glossy



THOBHAN 7009
Color : Grey
Finish : Matt



FONZA 7004
Color : Black
Finish : Matt



FONZA 7004
Color : Green
Finish : Glossy



FONZA 7004
Color : Green
Finish : Matt



THOBHAN 7009
Color : Green
Finish : Glossy



THOBHAN 7009
Color : Green
Finish : Matt



THOBHAN 7009
Color : Parrot Green
Finish : Matt



FONZA 7004
Color : Blue
Finish : Matt



FONZA 7004
Color : Copper
Finish : Matt



FONZA 7004
Color : Parrot Green
Finish : Matt



THOBHAN 7009
Color : Black
Finish : Glossy



THOBHAN 7009
Color : Black
Finish : Matt



THOBHAN 7009
Color : Copper
Finish : Matt

TABLE TOP
Color Series



MARKEL 7025
Color : **Black**
Finish : **Glossy**



MARKEL 7025
Color : **Black**
Finish : **Matt**



MARKEL 7025
Color : **Green**
Finish : **Glossy**



MARKEL 7025
Color : **Green**
Finish : **Matt**



MARKEL 7025
Color : **Parrot Green**
Finish : **Matt**



MARKEL 7025
Color : **Grey**
Finish : **Matt**



MARKEL 7025
Color : **Sky Blue**
Finish : **Matt**



MARKEL 7025
Color : **Copper**
Finish : **Matt**

TABLE TOP
Designer Series



ELINE 7001-001
415 x 345 x 165mm
16 x 14 Inch (Approx)



ELINE 7001-002
415 x 345 x 165mm
16 x 14 Inch (Approx)



ELINE 7001-003
415 x 345 x 165mm
16 x 14 Inch (Approx)



ELINE 7001-004
415 x 345 x 165mm
16 x 14 Inch (Approx)



ELINE 7001-005
415 x 345 x 165mm
16 x 14 Inch (Approx)



ELINE 7001-006
415 x 345 x 165mm
16 x 14 Inch (Approx)



ELINE 7001-007
415 x 345 x 165mm
16 x 14 Inch (Approx)



LONZA 7003-001
460 x 335 x 135mm
18 x 13 Inch (Approx)



LONZA 7003-002
460 x 335 x 135mm
18 x 13 Inch (Approx)

TABLE TOP Designer Series



LONZA 7003-003
460 x 335 x 135mm
18 x 13 Inch (Approx)



LONZA 7003-004
460 x 335 x 135mm
18 x 13 Inch (Approx)



LONZA 7003-005
460 x 335 x 135mm
18 x 13 Inch (Approx)



LONZA 7003-006
460 x 335 x 135mm
18 x 13 Inch (Approx)



LONZA 7003-007
460 x 335 x 135mm
18 x 13 Inch (Approx)



LONZA 7003-008
460 x 335 x 135mm
18 x 13 Inch (Approx)



FONZA 7004-101
480 x 390 x 150mm
19 x 15 Inch (Approx)



FONZA 7004-102
480 x 390 x 150mm
19 x 15 Inch (Approx)



FONZA 7004-103
480 x 390 x 150mm
19 x 15 Inch (Approx)

Installation instruction

WALL HUNG BASIN

- 1) The rag bolt should be first grouted into the wall using cement/concrete, (as shown) as per distance between slots provided in the wash basin. The bolts should be fixed perpendicular to the wall. Allow cement/concrete to set. Check if the Rag Bolts are firmly fixed. Fix the Wash Basin in the bolt using Nut & Washer.
- 2) If brackets are use, prefer nylon or aluminum instead of iron brackets as it tends to rust.
- 3) If small basins are screwed to wall, use nylon washers and steel screws.
- 4) While fixing waste outlet, ensure that the rubber washer is placed on the outlet under the basin.

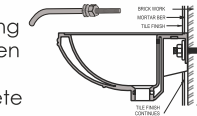

COUNTER WASHBASIN

- At the beginning
1. A skilled or experienced person should install counter lavatories.
 2. Avoid using adhesive with this product.
 3. Check the waste area and supply tubing if required.
 4. Do not open the lavatory from its protective carton until you are ready for installation.
 5. Please follow all local building and plumbing codes.

MATERIAL & TOOLS

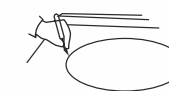

Measure tape, keyhole or saber saw, Hammer, Glasses, Rage or Paper toweling, Drill (1/2 dia, drill bit or larger), Pencil, sealant, sharp knife or scissors.

INSTALLATION OF LAVATORY

Please Note : Please install it in a way that future removal from underneath the counter top is possible without damaging the counter top.

1. Please check the desired location for clearance between the back splash, faucet, fixture and cabinet.
2. Please cut the template.
3. Please carefully trace the template on the counter top as directed.
4. Please mark the faucet hole centerline on the counter top.
5. Please drill a 1/2" pilot on the inside of the cut line.

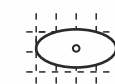

For Wood Counter tops:

1. Mark and pre-drill the wood screw holes at the locations shown on the template.
2. Waterproof any exposed areas of wood.

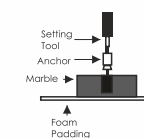

For Marble Counter tops:

1. Position the counter top upside down on foam padding to protect the surface. Mark and drill 3/6" holes 5/8" deep at the locations shown on the template.
2. Use a setting tools and hammer to secure the anchors.



For All Installations :

1. If the counter top has not been installed, install it at this time.
2. Drill the faucet holes according to the faucet installation instructions.
3. Install the faucet to the counter top according to the manufacture's instructions.
4. Install the drain to the lavatory according to the manufacture's instructions.

INSTALLATION DETAILS OF WALL HUNG

CONCEALED WALLHUNG

1. If the wall is going to be plastered for a thickness of 12 mm and a tile thickness of 6-7 mm, the projection of the bolts from the finished wall should be 66mm only.
2. If the thickness of Plastering and tile is less than the dimensions mentioned above, the bolts that are supplied along with the bracket should be moved into the wall by using a suitable spacer washer between the bolt head and the bracket frame.
3. The bracket should be buried into the floor so that the height from the center line of the bolt to the surface of the finished floor is 320mm.

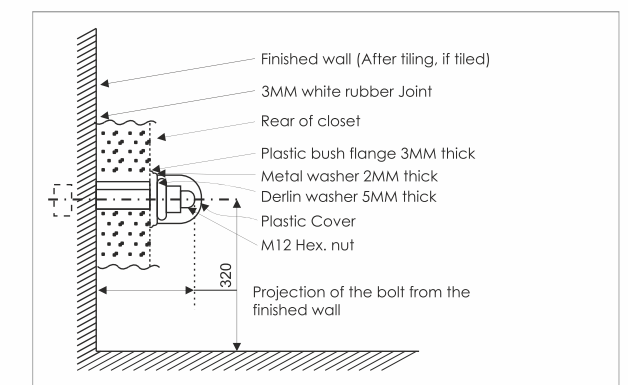
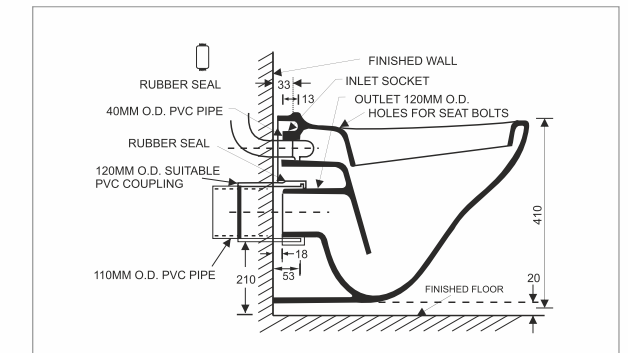

MAINTENANCE

Like any other part of your houses, the bathroom can be made to look great and made to last long if it is taken care of regularly. To make your bathroom beautiful here are some invaluable tips.

Wash Basin

A mild detergent can be used to wash the basin at least once a day. After washing, the basin should be wiped out clearly to avoid water stains.

Closets

Cleanser like harpic can be used to clear the closet with soft plastic brush, at least once a day. To avoid minute discoloring, after flushing the toilet give it a once over with the soft brush.

Keep the toilet brush handy in a convenient stand nearby. In case toilet and basins, if there has been no maintenance since long period of time, water deposit and discoloration can form on the surface of areas that get wet, In such cases, these stains/marks can be removed with the help of a solution of dilute hydrochloric acid. Clean with a soft cotton cloth and warm water with soap. Do not use thinner, dry cleaning liquids or powder paste. Use a liquid cleaner at least twice a week. Use Brasso or car rubbing compound and then polish with a cloth to remove fine scratches.

